

**PLEASE CHECK WWW.MOLEX.COM FOR LATEST PART INFORMATION**

**Part Number:** [0930700001](#)  
**Status:** **Active**  
**Overview:** [rast\\_25\\_connector\\_system](#)  
**Description:** 2.50mm (.098") Pitch Appli-Mate RAST 2.5 Header, Vertical, 3 Circuits, Glow Wire Compatible, with Latch, Positioning Keys None

**Documents:**

[3D Model](#) [RoHS Certificate of Compliance \(PDF\)](#)  
[Drawing \(PDF\)](#)

**Agency Certification**

UL E29179

**General**

Product Family PCB Headers  
 Series [93070](#)  
 Application Wire-to-Board  
 Overview [rast\\_25\\_connector\\_system](#)  
 Product Name RAST 2.5

**Physical**

Breakaway No  
 Circuits (Loaded) 3  
 Circuits Detail 3  
 Color - Resin Natural  
 Durability (mating cycles max) 10  
 First Mate / Last Break No  
 Flammability 94V-0  
 Glow-Wire Compliant Yes  
 Guide to Mating Part No  
 Keying to Mating Part None  
 Lock to Mating Part Yes  
 Material - Metal Brass  
 Material - Plating Mating Tin  
 Material - Plating Termination Tin  
 Material - Resin Nylon  
 Number of Rows 1  
 Orientation Vertical  
 PC Tail Length (in) 0.130 In  
 PC Tail Length (mm) 3.30 mm  
 PCB Locator Yes  
 PCB Retention None  
 PCB Thickness Recommended (in) 0.059 In  
 PCB Thickness Recommended (mm) 1.50 mm  
 Packaging Type Carton  
 Pitch - Mating Interface (in) 0.098 In  
 Pitch - Mating Interface (mm) 2.50 mm  
 Polarized to PCB Yes  
 Stackable No  
 Surface Mount Compatible (SMC) No  
 Temperature Range - Operating -20C TO +120C  
 Termination Interface: Style Through Hole

**Electrical**

Current - Maximum per Contact 6A  
 Voltage - Maximum 32V

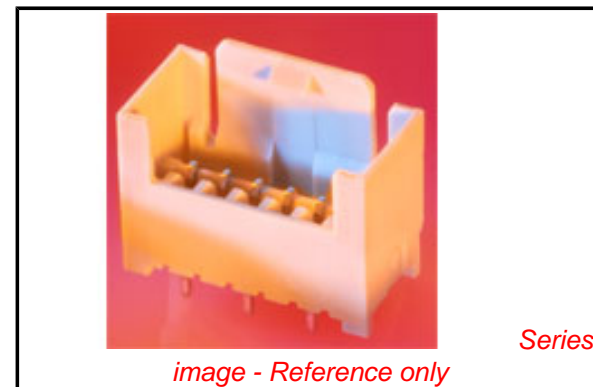

**EU RoHS**

**ELV and RoHS  
 Compliant  
 REACH SVHC  
 Not Reviewed  
 Halogen-Free  
 Status  
 Not Reviewed**

**China RoHS**



**Need more information on product  
 environmental compliance?**

Email [productcompliance@molex.com](mailto:productcompliance@molex.com)  
 For a multiple part number RoHS Certificate of Compliance, [click here](#)

Please visit the [Contact Us](#) section for any non-product compliance questions.

**Search Parts in this Series**  
[93070Series](#)

**Material Info**

**Reference - Drawing Numbers**

Packaging Specification

PK-93070-001

Sales Drawing

SD-93070-001

This document was generated on 06/08/2010

**PLEASE CHECK [WWW.MOLEX.COM](http://WWW.MOLEX.COM) FOR LATEST PART INFORMATION**

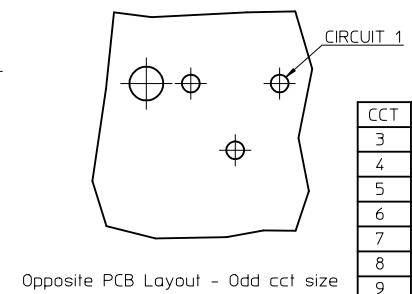
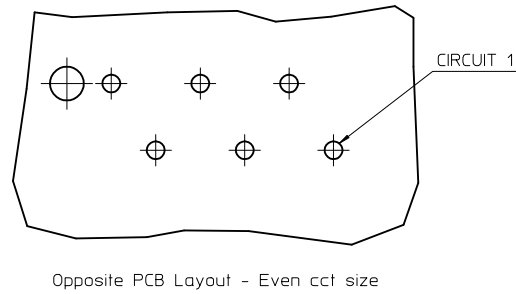
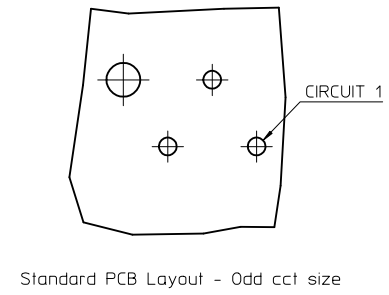
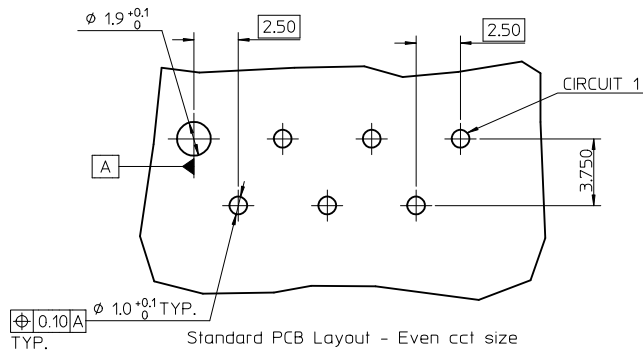
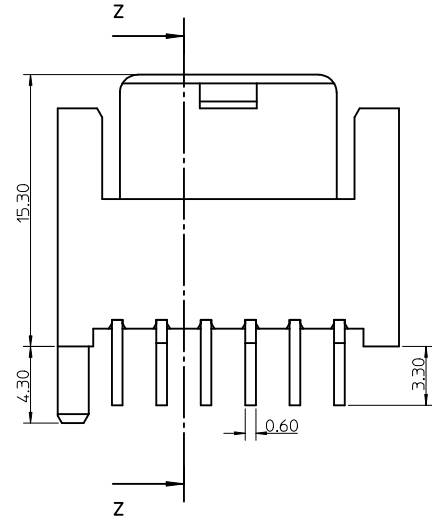
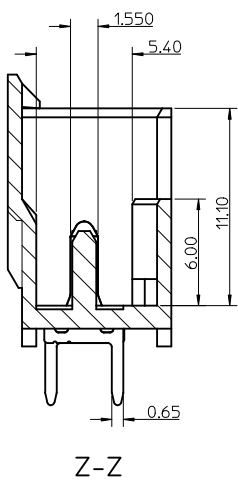
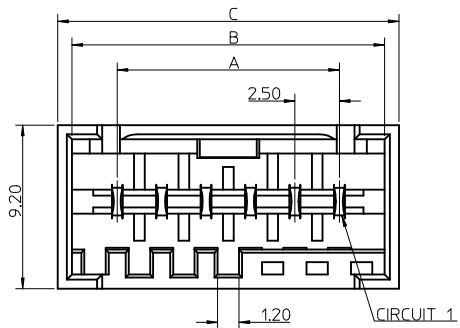

CCT	A	B	C
3	5.00	10.10	11.70
4	7.50	12.60	14.20
5	10.00	15.10	16.70
6	12.50	17.60	19.20
7	15.00	20.10	21.70
8	17.50	22.60	24.20
9	20.00	25.10	26.70
10	22.50	27.60	29.20
11	25.00	30.10	31.70
12	27.50	32.60	34.20
13	30.00	35.10	36.70
14	32.50	37.60	39.20
15	35.00	40.10	41.70

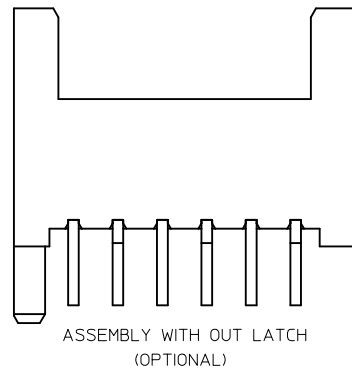

NOTES:

1. MATERIAL: HOUSING - PA66 25% G/F, UL94 V-0  
COLOUR: NATURAL  
TERMINAL - BRASS  
PLATING - 3-7um Sn over 1.27um Min Ni
2. PARTS PACKED AS PER PK-90370-001
3. PRODUCT SPECIFICATION: PS-93070-001
4. RECOMMENDED PCB THICKNESS: 1.5+/-0.14mm

<b>ADDED NEW P/NS</b> EC NO: E2010-0255 DRAWN: T.OURISH 2010/01/13 CHKD: BRITTLE 2010/01/19 APPR: BMAGUIRE 2010/01/19	QUALITY SYMBOLS $\nabla=0$ $\nabla=0$	GENERAL TOLERANCES (UNLESS SPECIFIED)		DIMENSION STYLE <b>MM ONLY</b>		SCALE <b>5:1</b>	DESIGN UNITS <b>METRIC</b>	THIRD ANGLE PROJECTION
		4 PLACES $\pm$ --- $\pm$ --- 3 PLACES $\pm 0.05$ $\pm$ --- 2 PLACES $\pm 0.10$ $\pm$ --- 1 PLACE $\pm 0.20$ $\pm$ --- ANGULAR $\pm 2^\circ$	mm INCH	DRAWN BY T.OURISH CHECKED BY BRITTLE APPROVED BY BMAGUIRE	DATE 2008/03/14 DATE 2008/03/14 DATE 2008/03/14	TITLE <b>RAST 2.5 APPLI-MATE VERTICAL MALE HEADER 2.5 PITCH</b>	<b>MOLEX INCORPORATED</b>	MATERIAL NO. <b>SD-93070-001</b>
DRAFT WHERE APPLICABLE MUST REMAIN WITHIN DIMENSIONS		<b>SEE SHEET 2&amp;3</b>		THIS DRAWING CONTAINS INFORMATION THAT IS PROPRIETARY TO MOLEX INCORPORATED AND SHOULD NOT BE USED WITHOUT WRITTEN PERMISSION				DOCUMENT NO.

### 3 CIRCUIT

MOLEX PART NO.	BLOCKED POSITION KEYS	TERMINAL VOID POSITION	CONFIGURATION	LATCH	CCT 1 LOCATION
93070-0001	NONE	NONE		YES	STANDARD
93070-0002	b d	NONE		YES	STANDARD
93070-0003	b c	NONE		YES	STANDARD
93070-0004	d	NONE		YES	STANDARD
93070-0005	a	NONE		YES	STANDARD
93070-0006	a b	NONE		YES	STANDARD
93070-0007	a c	NONE		YES	STANDARD
93070-0008	a d	NONE		YES	STANDARD
93070-0009	c d	NONE		YES	STANDARD
93070-0010	b	NONE		YES	STANDARD

### 4 CIRCUIT

MOLEX PART NO.	BLOCKED POSITION KEYS	TERMINAL VOID POSITION	CONFIGURATION	LATCH	CCT 1 LOCATION
93070-0501	NONE	NONE		YES	STANDARD
93070-0502	b c	NONE		YES	STANDARD
93070-0503	b c	CCT 4		YES	STANDARD
93070-0504	c d	NONE		YES	STANDARD
93070-0505	NONE	CCT 1		YES	STANDARD
93070-0601	b c	NONE		YES	<b>OPPOSITE</b>
93070-0506	b	NONE		YES	STANDARD
93070-0507	c	NONE		YES	STANDARD
93070-0508	d	NONE		YES	STANDARD
93070-0509	a c d	NONE		YES	STANDARD
93070-0510	b c d	NONE		YES	STANDARD

### 6 CIRCUIT

MOLEX PART NO.	BLOCKED POSITION KEYS	TERMINAL VOID POSITION	CONFIGURATION	LATCH	CCT 1 LOCATION
93070-1501	NONE	NONE		YES	STANDARD
93070-1502	d f	CCT 2, 5		YES	STANDARD
93070-1503	c e	NONE		YES	STANDARD
93070-1505	d f	NONE		YES	STANDARD
93070-1506	b d f	CCT 4, 5		YES	STANDARD
93070-1507	NONE	CCT 2		YES	STANDARD
93070-1508	c f	CCT 2		YES	STANDARD
93070-1509	d	NONE		YES	STANDARD
93070-1510	a b c e f	NONE		YES	STANDARD
93070-1511	e f	NONE		YES	STANDARD

### 5 CIRCUIT

MOLEX PART NO.	BLOCKED POSITION KEYS	TERMINAL VOID POSITION	CONFIGURATION	LATCH	CCT 1 LOCATION
93070-1001	NONE	NONE		YES	STANDARD
93070-1002	c d	NONE		YES	STANDARD
93070-1003	a d f	NONE		YES	STANDARD
93070-1101	NONE	NONE		YES	<b>OPPOSITE</b>
93070-1004	d	NONE		YES	STANDARD
93070-1005	a b e f	NONE		YES	STANDARD
93070-1006	b c d e	NONE		YES	STANDARD

NOTES:  
 1. + DENOTES TERMINAL VOIDED POSITION  
 ⊕ DENOTES TERMINAL LOADED POSITION

SEE SHEET 1 ELEC NO: E2070-0255 DRAWN BY: TOURISH CHKD BY: BRUTTLE APPR BY: BMAGUIRE	QUALITY SYMBOLS	GENERAL TOLERANCES (UNLESS SPECIFIED)	DIMENSION STYLE	SCALE	DESIGN UNITS	THIRD ANGLE PROJECTION	
	▽=0	mm INCH	MM ONLY	1:1	METRIC		
	▽=0	4 PLACES ± --- ± --- 3 PLACES ± 0.05 ± --- 2 PLACES ± 0.10 ± --- 1 PLACE ± 0.20 ± ---	DRAWN BY DATE TOURISH 2008/03/14	CHECKED BY DATE BRUTTLE 2008/03/14	TITLE <b>RAST 2.5 APPLI-MATE          VERTICAL MALE HEADER          2.5 PITCH</b>		
		ANGULAR ± 2 °	APPROVED BY DATE BMAGUIRE 2008/03/14	MATERIAL NO.		DOCUMENT NO.	
DRAFT WHERE APPLICABLE MUST REMAIN WITHIN DIMENSIONS		SEE CHARTS		MOLEX INCORPORATED			
		SIZE 1		SD-93070-001			
		THIS DRAWING CONTAINS INFORMATION THAT IS PROPRIETARY TO MOLEX INCORPORATED AND SHOULD NOT BE USED WITHOUT WRITTEN PERMISSION		SHEET NO. 2 OF 3			

### 7 CIRCUIT

MOLEX PART NO.	BLOCKED POSITION KEYS	TERMINAL VOID POSITION	CONFIGURATION	LATCH	CCT 1 LOCATION
93070-2001	NONE	NONE		YES	STANDARD
93070-2002	a f	CCT 2, 6		YES	STANDARD
93070-2003	d g	CCT 4		YES	STANDARD
93070-2004	a e	CCT 4		YES	STANDARD
93070-2005	d f g	CCT 4		YES	STANDARD
93070-2006	a f	CCT 4		YES	STANDARD
93070-2007	a	NONE		YES	STANDARD
93070-2008	NONE	CCT 2		YES	STANDARD
93070-2009	a	CCT 4		YES	STANDARD
93070-2010	h	CCT 2		YES	STANDARD
93070-2011	b e g	NONE		YES	STANDARD

### 8 CIRCUIT

MOLEX PART NO.	BLOCKED POSITION KEYS	TERMINAL VOID POSITION	CONFIGURATION	LATCH	CCT 1 LOCATION
93070-2501	NONE	NONE		YES	STANDARD
93070-2502	c f h i	NONE		YES	STANDARD
93070-2503	b c d h i	CCT 4, 7		YES	STANDARD
93070-2601	NONE	CCT 4, 7		YES	<b>OPPOSITE</b>
93070-2504	b c d h i	NONE		YES	STANDARD

### 9 CIRCUIT

MOLEX PART NO.	BLOCKED POSITION KEYS	TERMINAL VOID POSITION	CONFIGURATION	LATCH	CCT 1 LOCATION
93070-3001	NONE	NONE		YES	STANDARD
93070-3002	ALL	CCT 2, 5, 8		YES	STANDARD
93070-3101	NONE	CCT 3, 5, 8		YES	<b>OPPOSITE</b>
93070-3003	c d e i j	CCT 3, 5, 8		YES	STANDARD
93070-3004	NONE	CCT 2, 5, 8		YES	STANDARD

### 10 CIRCUIT

MOLEX PART NO.	BLOCKED POSITION KEYS	TERMINAL VOID POSITION	CONFIGURATION	LATCH	CCT 1 LOCATION
93070-3501	NONE	NONE		YES	STANDARD
93070-3502	NONE	CCT 2, 5, 7, 9		YES	STANDARD
93070-3503	a b d e f g i j	NONE		YES	STANDARD

### 11 CIRCUIT

MOLEX PART NO.	BLOCKED POSITION KEYS	TERMINAL VOID POSITION	CONFIGURATION	LATCH	CCT 1 LOCATION
93070-4001	NONE	NONE		YES	STANDARD

### 12 CIRCUIT

MOLEX PART NO.	BLOCKED POSITION KEYS	TERMINAL VOID POSITION	CONFIGURATION	LATCH	CCT 1 LOCATION
93070-4501	NONE	NONE		YES	STANDARD
93070-4502	NONE	CCT 2, 5, 8, 11		YES	STANDARD

### 13 CIRCUIT

MOLEX PART NO.	BLOCKED POSITION KEYS	TERMINAL VOID POSITION	CONFIGURATION	LATCH	CCT 1 LOCATION
93070-5001	NONE	NONE		YES	STANDARD
93070-5002	NONE	CCT 4, 6, 8, 10, 12		YES	STANDARD

### 14 CIRCUIT

MOLEX PART NO.	BLOCKED POSITION KEYS	TERMINAL VOID POSITION	CONFIGURATION	LATCH	CCT 1 LOCATION
93070-5501	NONE	NONE		YES	STANDARD

### 15 CIRCUIT

MOLEX PART NO.	BLOCKED POSITION KEYS	TERMINAL VOID POSITION	CONFIGURATION	LATCH	CCT 1 LOCATION
93070-6001	NONE	NONE		YES	STANDARD
93070-6002	o p	CCT 4, 6, 8, 10, 12, 14		YES	STANDARD
93070-6003	a d g i j n o p	NONE		YES	STANDARD

NOTES:  
 1. + DENOTES TERMINAL VOIDED POSITION  
 ⊕ DENOTES TERMINAL LOADED POSITION

SEE SHEET 1 EC NO: E2010-0255 DRAWN BY: TOURISH CHKD BY: BRUTTLE APPR: BMAGUIRE 2010/01/13 2010/01/19 2010/01/19	QUALITY SYMBOLS	GENERAL TOLERANCES (UNLESS SPECIFIED)	DIMENSION STYLE	SCALE	DESIGN UNITS	THIRD ANGLE PROJECTION
	$\nabla=0$ $\nabla=0$	mm INCH 4 PLACES ± --- ± --- 3 PLACES ± 0.05 ± --- 2 PLACES ± 0.10 ± --- 1 PLACE ± 0.20 ± --- ANGULAR ± 2°	MM ONLY DRAWN BY: TOURISH DATE: 2008/03/14 CHECKED BY: BRUTTLE DATE: 2008/03/14 APPROVED BY: BMAGUIRE DATE: 2008/03/14	1:1	METRIC	
	DRAFT WHERE APPLICABLE MUST REMAIN WITHIN DIMENSIONS	SEE CHARTS MATERIAL NO.	TITLE RAST 2.5 APPLI-MATE VERTICAL MALE HEADER 2.5 PITCH	MOLEX INCORPORATED DOCUMENT NO. SD-93070-001	SHEET NO. 3 OF 3	
	THIS DRAWING CONTAINS INFORMATION THAT IS PROPRIETARY TO MOLEX INCORPORATED AND SHOULD NOT BE USED WITHOUT WRITTEN PERMISSION					